

## ABOUT REPAIR OF BOARDS

The BC-WFSP700N (charging case) can be disassembled and repaired. However, when boards installed in the BC-WFSP700N (charging case) are defective, it is replaced by the board.

Replace the complete mounted board or the whole parts including the applicable board.

In addition, when replace the CRADLE NFC board, be sure to refer to “REPAIRING AND REPLACING OF THE BC-WFSP700N (charging case) OR THE CRADLE NFC BOARD” on page 9.

The WF-SP700NL (L-ch) and the WF-SP700NR (R-ch) can not be disassembled and repaired.

## OPERATION CHECK OF THE NFC FUNCTION AFTER COMPLETING THE REPAIRS

After completing the repairs of this unit, follow the procedure below to check normal operation of the NFC.

**Note:** After checking of NFC operation, be sure to delete the pairing information before returning this unit to the customer.

For deleting method of the pairing information, refer to “INITIALIZING METHOD” on page 6.

### Preparation:

- NFC compatible device (smartphone or music player etc.)

### Procedure:

1. Turn on the NFC function of the NFC compatible device. (For details, refer to the instruction manual of your NFC compatible device. The figure below is a reference example)



2. Remove the WF-SP700NL (L-ch) and WF-SP700NR (R-ch), from the BC-WFSP700N (charging case).

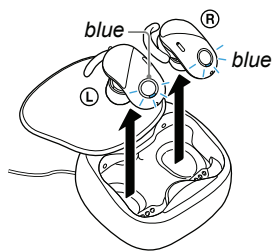

If it is already removed to the WF-SP700NL (L-ch) and WF-SP700NR (R-ch) from the BC-WFSP700N (charging case) and the power is off, put it in the charging case again and remove it, or press and hold the WF-SP700NL (L-ch) and WF-SP700NR (R-ch) buttons for about 2 seconds, then check that the blue lamp blinks.

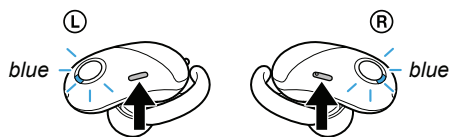

3. Touch and connection the N-mark part of the NFC compatible device to the N-mark part of the BC-WFSP700N (charging case).

**Note:** Please unlock if the screen of the NFC compatible device is locked.

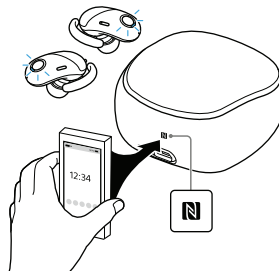

4. Playback the audio from the NFC compatible device and check that the sound is outputted from the WF-SP700NL (L-ch) and WF-SP700NR (R-ch).

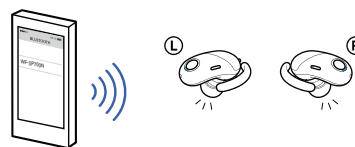

5. Touch the N-Mark part of the BC-WFSP700N (charging case) with N-Mark of the NFC compatible device again to disconnect the connection.
6. Refer to “INITIALIZING METHOD” on page 6, delete the device pairing information and complete the operation check.

**RESETTING METHOD**

If the unit does not operate properly, perform the reset.

**Note:** Even if this work is performed, device pairing information is not deleted. Also, other settings are retained.

**Procedure:**

1. Connect the BC-WFSP700N (charging case) to a optional USB AC adaptor using the supplied micro-USB cable, then the BC-WFSP700N (charging case) to the charging state, and check that the charging lamp lights up red.

**Note 1:** It can also use the micro-USB cable provided with this unit to connect the BC-WFSP700N (charging case) to the running PC to charge it.

**Note 2:** When charging with a PC, charging may not be possible when the PC is in standby (sleep) or hibernate.

**Note 3:** The charging lamp turns off when charging is completed.

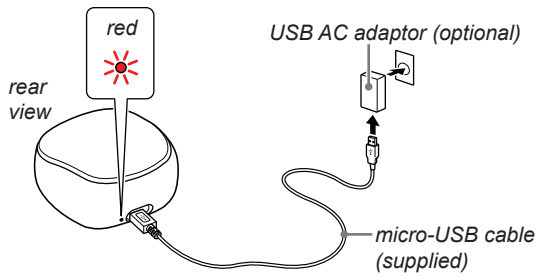

2. Open the lid of the BC-WFSP700N (charging case), insert the WF-SP700NL (L-ch) and WF-SP700NR (R-ch) and check that the WF-SP700NL (L-ch) and WF-SP700NR (R-ch) lamps are lit in red.

**Note 4:** Please lock the WF-SP700NL (L-ch) and WF-SP700NR (R-ch) securely to the BC-WFSP700N (charging case).

**Note 5:** The charging lamp turns off when charging is completed.

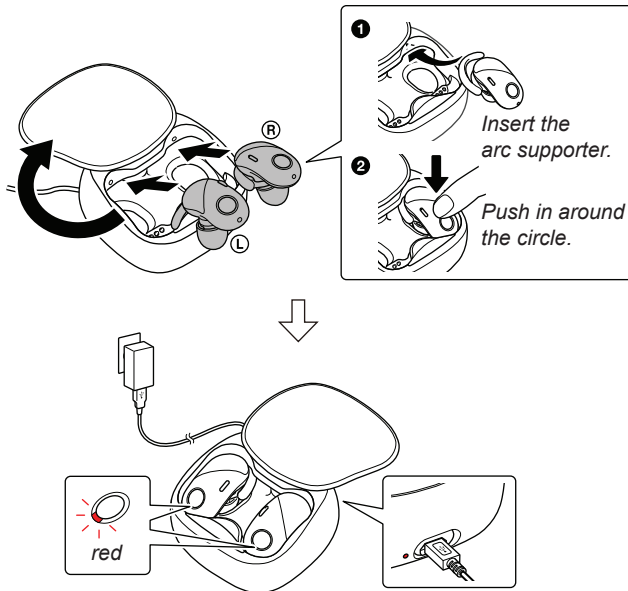

3. The WF-SP700NL (L-ch) and WF-SP700NR (R-ch) buttons are pressed simultaneously for about 7 seconds in the state of step 2, the red lamp flashes once and the reset is completed automatically.

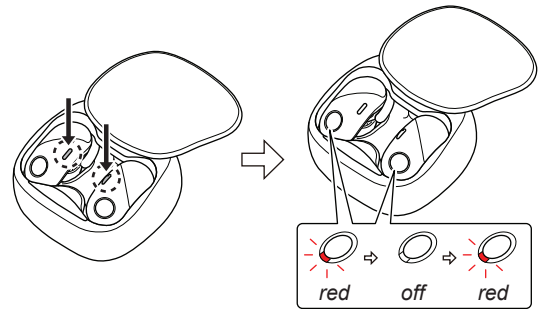

## INITIALIZING METHOD

After completion of repairs, be sure to perform the following procedure to initialize this unit.

**Note 1:** When this work is performed, all device pairing information is deleted and settings return to factory defaults.

### Procedure:

1. Remove the WF-SP700NL (L-ch) and WF-SP700NR (R-ch), from the BC-WFSP700N (charging case).

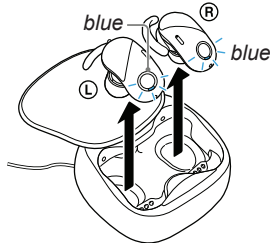

2. Press the button on the WF-SP700NL (L-ch) for more than about 2 seconds to turn the power off.

**Note 2:** By pressing the button on the WF-SP700NL (L-ch) for about 2 seconds or more, the WF-SP700NR (R-ch) also linked together and the power is turned off.

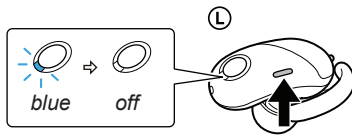

3. While the WF-SP700NL (L-ch) and WF-SP700NR (R-ch) turned power off state, pressing each buttons simultaneously for about 15 seconds or more.

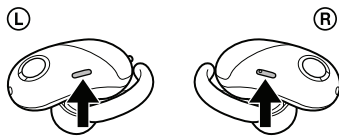

**Note 3:** While the buttons are pressing, the lamp of WF-SP700NL (L-ch) is flashes in the middle, but keep pressing for more than 15 seconds as it is.

4. When the lamps of the WF-SP700NL (L-ch) and WF-SP700NR (R-ch) are switched from flashing red several times to flashing blue 4 times and the lamps are turn off, and initialize is complete.

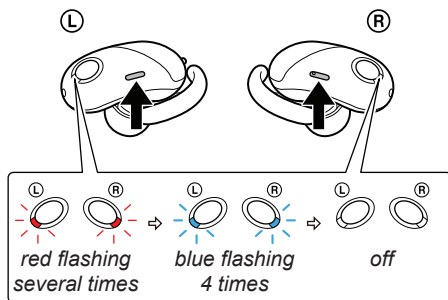

**Note 4:** When this unit is initialized, it might not be able to connect to iPhone or PC. In that case, delete the registration of this unit on iPhone or PC, register the device again.

## REPAIRING AND REPLACING OF THE WF-SP700NL (L-ch)

The WF-SP700NL (L-ch) will be replaced in the state of the finished product. It can not be repaired by disassembling the WF-SP700NL (L-ch).

Also, if replace the WF-SP700NL (L-ch), be sure to disassemble the BC-WFSP700N (charging case) and replace the CRADLE NFC board at the same time.

When replacing the WF-SP700NL (L-ch), perform the following procedure to works.

### Check in advance:

- Check in advance that you have all of WF-SP700NL (L-ch), WF-SP700NR (R-ch) and BC-WFSP700N (charging case).
- Be sure to check that there are no WF-SP700N in the surroundings. If using WF-SP700N in the surroundings, there is a possibility that is connect another WF-SP700N.

### Preparation:

- Windows PC with Bluetooth function
- NFC compatible smartphone that installed the NFC Tag Data Writing Application

**Note 1:** For the NFC Tag Data Writing Application, refer to “BLUETOOTH INFORMATION WRITING METHOD” on page 11.

**Note 2:** Confirm the method of obtaining the NFC Tag Data Writing Application and its latest version with the each service headquarters.

### Replacing procedure:

1. Replace the broken WF-SP700NL (L-ch) with a new WF-SP700NL (L-ch).

**Note 3:** Change the Long Hybrid silicone rubber earbud and the Arc supporter to new WF-SP700NL (L-ch) from the broken WF-SP700NL (L-ch).

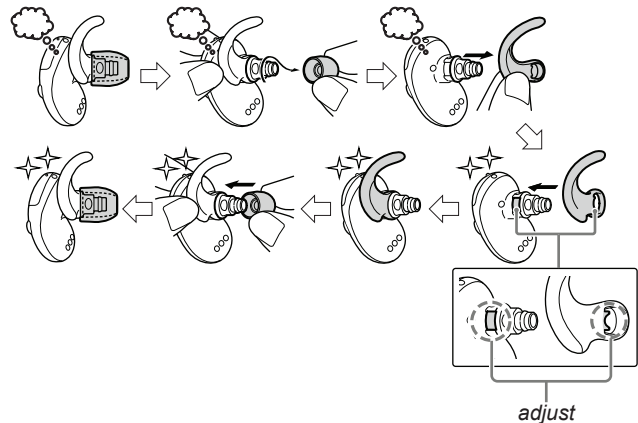

– Continued on next page –

- Refer to "2. DISASSEMBLY" on page 18, disassemble the BC-WFSP700N (charging case) and replace the CRADLE NFC board with new CRADLE NFC board and assemble as it was before.

**Note 4:** The figure below is an image figure. Be sure to refer to "2. DISASSEMBLY" on page 18.

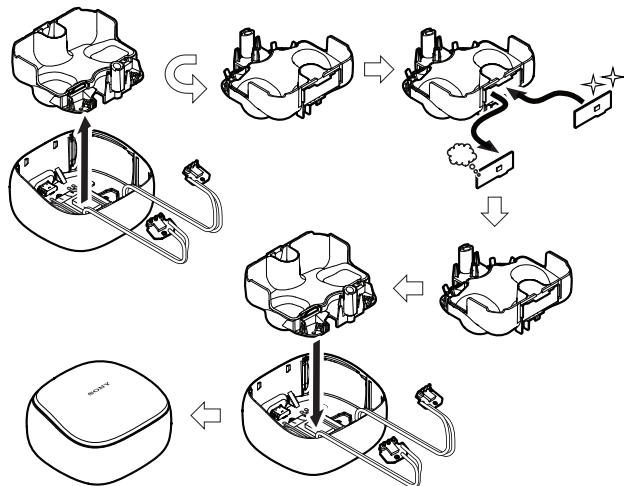

**Note 5:** The repair parts of WF-SP700NL (L-ch) do not include the CRADLE NFC board of inside the BC-WFSP700N (charging case). It is a single repair part each.

- Attach the WF-SP700NL (L-ch) and WF-SP700NR (R-ch) to the BC-WFSP700N (charging case).

**Note 6:** Please check that the WF-SP700NL (L-ch) and WF-SP700NR (R-ch) are locked to the BC-WFSP700N (charging case).

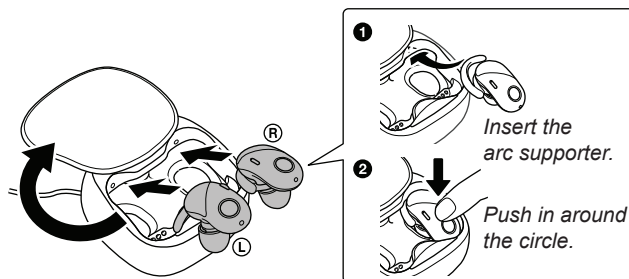

- Remove only the WF-SP700NL (L-ch) from the BC-WFSP700N (charging case).  
(The power on the WF-SP700NL (L-ch) automatically and the blue lamp flashes)

**Note 7:** Do not remove the WF-SP700NR (R-ch) from the BC-WFSP700N (charging case).

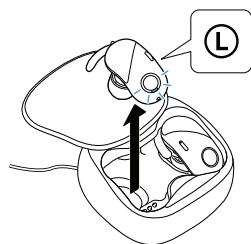

- Press the [⏻] button on the WF-SP700NL (L-ch) for about 7 seconds until the blue and red lamps alternately flash, put them in pairing state and connect to the PC with the Bluetooth function.

(In order to check the Bluetooth address, it is necessary to connect the PC and the WF-SP700NL (L-ch). It is also possible to display the Bluetooth address, by the Bluetooth connect to the walkman (NW-S series or NW-A series etc.) with Bluetooth function. In this example, describes how to display Bluetooth address on PC.)

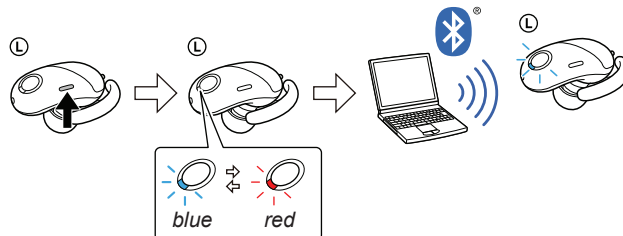

**Note 8:** For the Bluetooth connection method of the PC, refer to the manual of the PC to be used.

- Display information of this unit Bluetooth connected on the PC screen. Then open the property, display the Bluetooth address of this unit, and take a memorandum the Bluetooth address.

(In the Windows 8.1, open the "Control Panel → Device and Printers" in this order, right click the icon showing the model name (WF-SP700N) of this unit and open its properties)  
(The figure below is a reference example.)

"Device and Printers" screen on PC



Right click and select the "Properties".

"Properties" screen

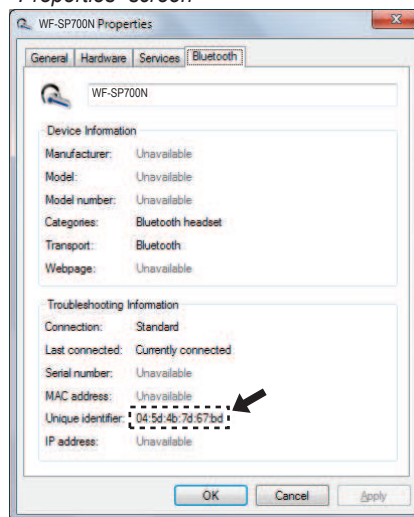

**Note 9 :** Check the device name carefully so as not to confuse Bluetooth address with other devices, and take a memorandum.

**Note 10:** The display method of Bluetooth address may be different depending on Windows OS.

- Write the Bluetooth information to the BC-WFSP700N (charging case) using NFC compatible smartphone that installed the NFC Tag Data Writing Application.  
(Refer to "BLUETOOTH INFORMATION WRITING METHOD" on page 11)

8. After writing Bluetooth information, with the power of WF-SP700NL (L-ch) and WF-SP700NR (R-ch) turned off state, press each buttons for about 15 seconds simultaneously.

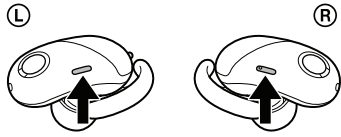

**Note 11:** If the power is on, press the [⏻] button on the WF-SP700NL (L-ch) for about 2 seconds or more and turn off the power before performing this step.

**Note 12:** While the buttons are pressing, the lamp of WF-SP700NL (L-ch) is flashes in the middle, but keep pressing for more than about 15 seconds as it is.

9. When the lamps of WF-SP700NL (L-ch) and WF-SP700NR (R-ch) are switched from flashing red several times to flashing blue 4 times and the lamps are turn off, pairing of WF-SP700NL (L-ch) and WF-SP700NR (R-ch) are completed.

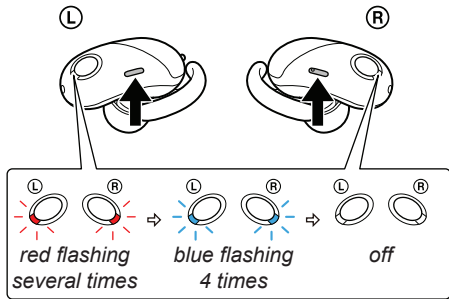

**Note 13:** When this unit is initialized, it might not be able to connect to iPhone or PC. In that case, delete the registration of this unit on iPhone or PC, register the device again.

10. Check the operation of this unit and complete replacement works.

**REPAIRING AND REPLACING OF THE WF-SP700NR (R-ch)**

The WF-SP700NR (R-ch) will be replaced in the state of the finished product. It can not be repaired by disassembling the WF-SP700NR (R-ch).

When replacing the WF-SP700NR (R-ch), perform the following procedure to works.

**Check in advance:**

- Check in advance that you have all of WF-SP700NL (L-ch), WF-SP700NR (R-ch) and BC-WFSP700N (charging case).
- Be sure to check that there are no WF-SP700N in the surroundings. If using WF-SP700N in the surroundings, there is a possibility that is connect another WF-SP700N.

**Replacing procedure:**

1. Replace the broken WF-SP700NR (R-ch) with a new WF-SP700NR (R-ch).

**Note 1:** Change the Long Hybrid silicone rubber earbud and the Arc supporter to new WF-SP700NR (R-ch) from the broken WF-SP700NR (R-ch).

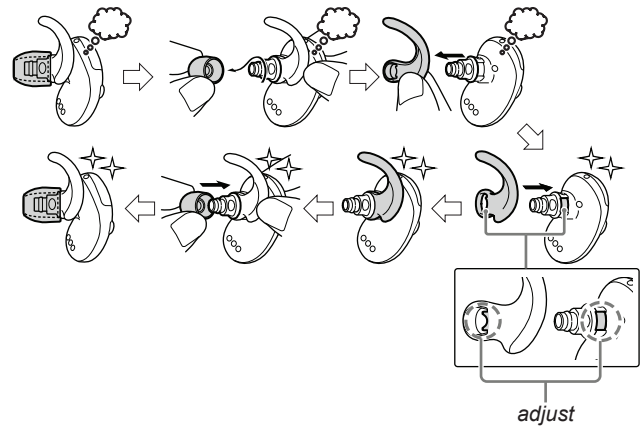

2. The power of WF-SP700NL (L-ch) and WF-SP700NR (R-ch) turned off state, press each buttons for about 15 seconds simultaneously.

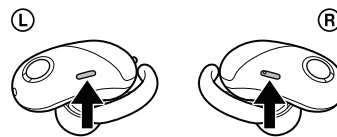

**Note 2:** If the power is on, press the [⏻] button on the WF-SP700NL (L-ch) for about 2 seconds or more and turn off the power before performing this step.

**Note 3:** While the buttons are pressing, the lamp of WF-SP700NL (L-ch) is flashes in the middle, but keep pressing for more than about 15 seconds as it is.

– Continued on next page –

- When the lamps of WF-SP700NL (L-ch) and WF-SP700NR (R-ch) are switched from flashing red several times to flashing blue 4 times and the lamps are turn off, pairing of WF-SP700NL (L-ch) and WF-SP700NR (R-ch) are completed.

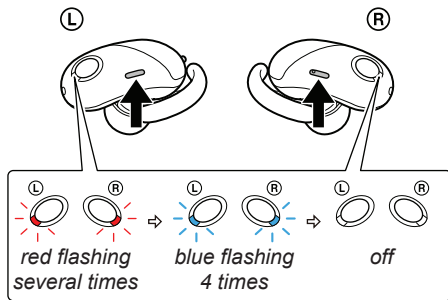

**Note 4:** When this unit is initialized, it might not be able to connect to iPhone or PC. In that case, delete the registration of this unit on iPhone or PC, register the device again.

- Check the operation of this unit and complete replacement works.

**REPAIRING AND REPLACING OF THE BC-WFSP700N (charging case) OR THE CRADLE NFC BOARD**

The BC-WFSP700N (charging case) can be disassembled and repaired.

When disassembling and repairing, refer to “2. DISASSEMBLY” on page 18 and “3. EXPLODED VIEWS” on page 26.

However, when replacing the BC-WFSP700N (charging case) whole, or when replacing the CRADLE NFC board of the internal, be sure to perform the following procedure to works.

**Check in advance:**

- Check in advance that you have all of WF-SP700NL (L-ch), WF-SP700NR (R-ch) and BC-WFSP700N (charging case).
- Be sure to check that there are no WF-SP700N in the surroundings. If using WF-SP700N in the surroundings, there is a possibility that is connect another WF-SP700N.

**Preparation:**

- Windows PC with Bluetooth function
- NFC compatible smartphone that installed the NFC Tag Data Writing Application

**Note 1:** For the NFC Tag Data Writing Application, refer to “BLUETOOTH INFORMATION WRITING METHOD” on page 11.

**Note 2:** Confirm the method of obtaining the NFC Tag Data Writing Application and its latest version with the each service headquarters.

**Replacing procedure:**

- Replace the broken BC-WFSP700N (charging case) with a new BC-WFSP700N (charging case), or refer to “2. DISASSEMBLY” on page 18 and replace the broken CRADLE NFC board with a new CRADLE NFC board and the BC-WFSP700N (charging case) assemble as it was before.

**Note 3:** The figure below is an image figure. Be sure to refer to “2. DISASSEMBLY” on page 18.

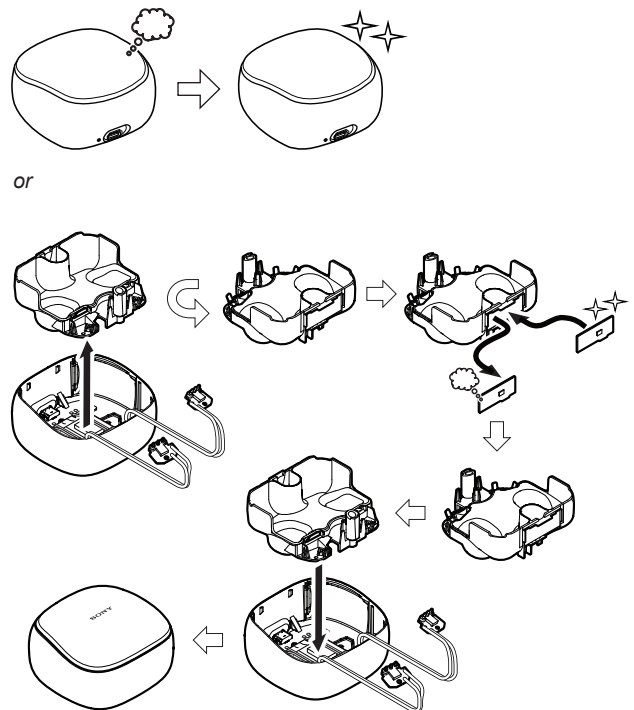

– Continued on next page –

# WF-SP700N

- Attach the WF-SP700NL (L-ch) and WF-SP700NR (R-ch) to the BC-WFSP700N (charging case).

**Note 4:** Please check that the WF-SP700NL (L-ch) and WF-SP700NR (R-ch) are locked to the BC-WFSP700N (charging case).

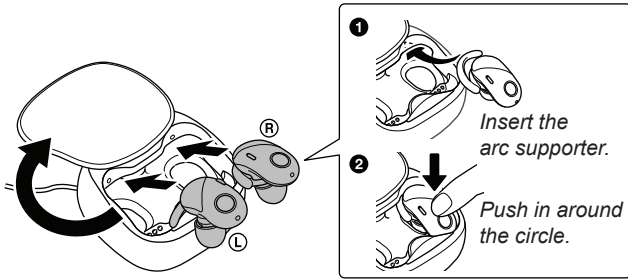

- Remove only the WF-SP700NL (L-ch) from the BC-WF-SP700N (charging case).  
(The power on the WF-SP700NL (L-ch) automatically and the blue lamp flashes)

**Note 5:** Do not remove the WF-SP700NR (R-ch) from the BC-WF-SP700N (charging case).

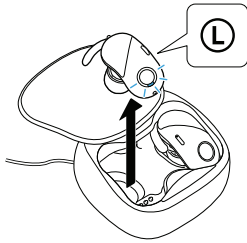

- Press the [P] button on the WF-SP700NL (L-ch) for about 7 seconds until the blue and red lamps alternately flash, put them in pairing state and connect to the PC with the Bluetooth function.

(In order to check the Bluetooth address, it is necessary to connect the PC and the WF-SP700NL (L-ch). It is also possible to display the Bluetooth address, by the Bluetooth connect to the walkman (NW-S series or NW-A series etc.) with Bluetooth function. In this example, describes how to display Bluetooth address on PC.)

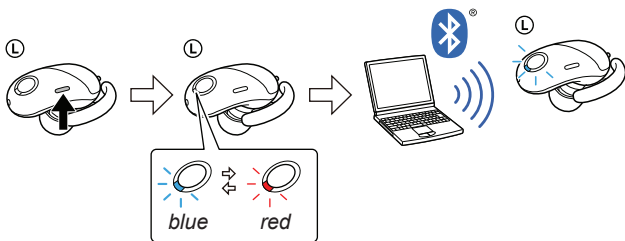

**Note 6:** For the Bluetooth connection method of the PC, refer to the manual of the PC to be used.

- Display information of this unit Bluetooth connected on the PC screen. Then open the property, display the Bluetooth address of this unit, and take a memorandum the Bluetooth address.

(In the Windows 8.1, open the “Control Panel → Device and Printers” in this order, right click showing the model name (WF-SP700N) of this unit and open its properties)  
(The figure below is a reference example.)

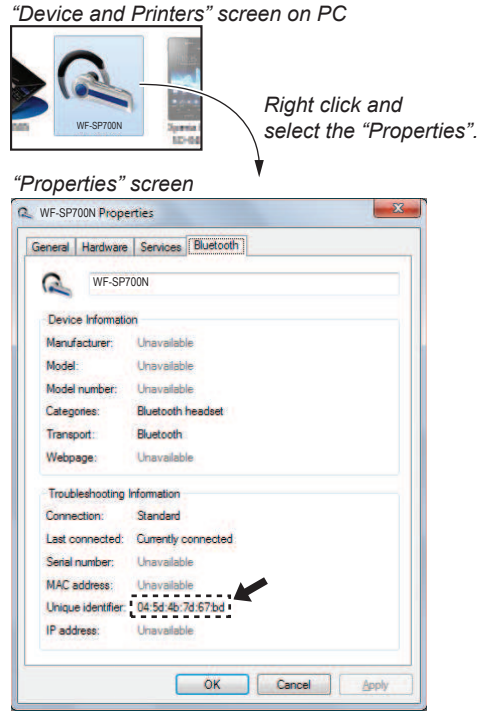

**Note 7:** Check the device name carefully so as not to confuse Bluetooth address with other devices, and take a memorandum.

**Note 8:** The display method of Bluetooth address may be different depending on Windows OS.

- Write the Bluetooth information to the BC-WFSP700N (charging case) using NFC compatible smartphone that installed the NFC Tag Data Writing Application.  
(Refer to “BLUETOOTH INFORMATION WRITING METHOD” on page 11)
- After writing Bluetooth information, with the power of WF-SP700NL (L-ch) and WF-SP700NR (R-ch) turned off state, press each buttons for about 15 seconds simultaneously.



**Note 9 :** If the power is on, press the [P] button on the WF-SP700NL (L-ch) for about 2 seconds or more and turn off the power before performing this step.

**Note 10:** While the buttons are pressing, the lamp of WF-SP700NL (L-ch) is flashes in the middle, but keep pressing for more than about 15 seconds as it is.

– Continued on next page –

8. When the lamps of WF-SP700NL (L-ch) and WF-SP700NR (R-ch) are switched from flashing red several times to flashing blue 4 times and the lamps are turn off, pairing of WF-SP700NL (L-ch) and WF-SP700NR (R-ch) are completed.

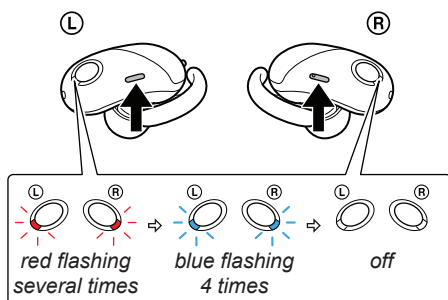

**Note 11:** When this unit is initialized, it might not be able to connect to iPhone or PC.

In that case, delete the registration of this unit on iPhone or PC, register the device again.

9. Check the operation of this unit and complete replacement works.

## BLUETOOTH INFORMATION WRITING METHOD

When the WF-SP700NL (L-ch), BC-WFSP700N (charging case) is replaced, or the CRADLE NFC board of inside the BC-WFSP700N (charging case) is replaced, it is necessary to perform writing of Bluetooth information.

Write the Bluetooth information according to the procedure below.

### Preparation:

- Windows PC with Bluetooth function
- NFC compatible smartphone that installed the file manager application (ASTRO File Manager, File Expert, etc.)
- USB cable for the smartphone
- NFC Tag Data Writing Application  
(Application name: mdr-nfc-tag-writer\_1.0.0.apk)

**Note 1:** "1.0.0" in the file name indicates the version of NFC Tag Data Writing Application. Always use the latest version of the NFC Tag Data Writing Application.

Example: mdr-nfc-tag-writer\_1.0.0.apk

└ version

**Note 2:** Confirm the method of obtaining the NFC Tag Data Writing Application and its latest version with the each service headquarters.

### Notes on the use of the NFC Tag Data Writing Application

- The NFC Tag Data Writing Application may be updated irregularly.  
Always use the latest version of the NFC Tag Data Writing Application.  
The version of NFC Tag Data Writing Application is represented by the file name of NFC Tag Data Writing Application.  
Example: mdr-nfc-tag-writer\_1.0.0.apk  
└ version
- Be sure to uninstall older versions of the NFC Tag Data Writing Application before installing the latest version.
- The NFC Tag Data Writing Application is also used in models other than the headphone category, and there are multiple types. If multiple NFC Tag Data Writing Applications are installed on a smartphone, do not launch more than one at the same time.
- The NFC Tag Data Writing Application varies depending on your model.  
Be sure to use the specified NFC Tag Data Writing Application.  
Use of not specified NFC Tag Data Writing Application is strictly prohibited.

## 1. Installing the NFC Tag Data Writing Application

Install the NFC Tag Data Writing Application on the smartphone for writing of Bluetooth information.

If the NFC Tag Data Writing Application is already installed, confirm the following.

- Be absolutely sure that the NFC Tag Data Writing Application supports your model.
- Confirm that the NFC Tag Data Writing Application is the latest version.

The version of NFC Tag Data Writing Application is represented by the file name.

Example: mdr-nfc-tag-writer\_1.0.0.apk

└ version